

Features

- Low power consumption
- Low voltage drop
- Low temperature coefficient
- High input voltage - up to 30V
- Output voltage accuracy: tolerance $\pm 3\%$
- Over current protection
- Package types: 3-pin SOT89 and 8-pin SOP-EP

Applications

- Battery-powered equipment
- Communication equipment
- Audio/Video equipment

General Description

The HT73xx-1 device series are low power high voltage regulators implemented in CMOS technology which have the advantages of low voltage drop and low quiescent current. They allow input voltages as high as 30V. They are available with several fixed output voltages ranging from 2.1V to 5.0V. The soft-start function inhibits the problem of output overshoot during power on.

Although designed primarily as fixed voltage regulators, these devices can be used with external components to obtain variable voltages and currents.

Selection Table

Part No.	Output Voltage	Package	Marking
HT7321-1	2.1V	SOT89 8SOP-EP	73xx-1 (for SOT89) HT73xx-1 (for 8SOP-EP)
HT7323-1	2.3V		
HT7325-1	2.5V		
HT7327-1	2.7V		
HT7330-1	3.0V		
HT7333-1	3.3V		
HT7336-1	3.6V		
HT7340-1	4.0V		
HT7344-1	4.4V		
HT7350-1	5.0V		

Note: "xx" stands for output voltages.

Block Diagram

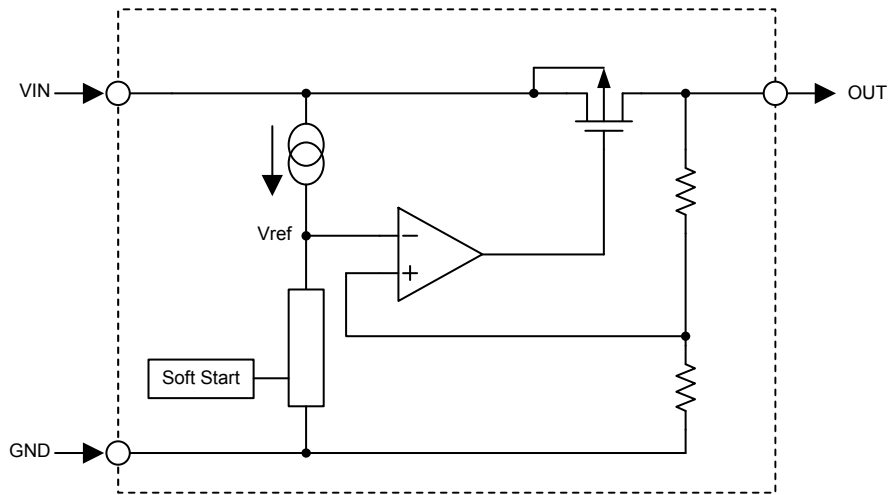

Pin Assignment

SOT89

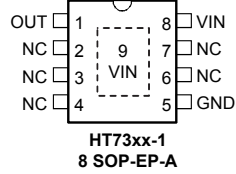
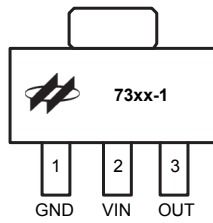

Pin Descriptions

Pin No.		Pin Name	Pin Description
SOT89	8SOP-EP		
1	5	GND	Ground pin
2	8, 9	VIN	Input pin
3	1	OUT	Output pin
—	2, 3, 4, 6, 7	NC	No connection

Absolute Maximum Ratings

Parameter	Value	Unit	
V_{IN}	-0.3 to +33	V	
Operating Temperature Range, T_a	-40 to +85	°C	
Maximum Junction Temperature, $T_{J(MAX)}$	+150	°C	
Storage Temperature Range	-65 to +165	°C	
Junction-to-Ambient Thermal Resistance, θ_{JA}	SOT89	200	°C/W
	8SOP-EP	125	°C/W
Power Dissipation, $P_{D(MAX)}$	SOT89	0.50	W
	8SOP-EP	0.80	W

Note: $P_{D(MAX)}$ is measured at $T_a = 25^\circ\text{C}$

Recommended Operating Range

Parameter	Value	Unit
V_{IN}	$V_{OUT}+2$ to 30	V

Electrical Characteristics

$V_{IN}=(V_{OUT}+2V)$, $T_a=+25^\circ\text{C}$ and $C_{IN}=C_{OUT}=10\mu\text{F}$, unless otherwise specified

Symbol	Parameter	Test Conditions	Min.	Typ.	Max.	Unit
V_{IN}	Input Voltage	—	—	—	30	V
V_{OUT}	Output Voltage Range	—	2.1	—	5.0	V
V_o	Output Voltage Accuracy	$I_{OUT}=10\text{mA}$	-3	—	3	%
I_{OUT}	Output Current	—	250	—	—	mA
ΔV_{OUT}	Load Regulation	$1\text{mA} \leq I_{OUT} \leq 100\text{mA}$	—	45	90	mV
V_{DIF}	Dropout Voltage	$I_{OUT}=1\text{mA}$, V_{OUT} Change=2% (Note)	—	6	15	mV
		$I_{OUT}=30\text{mA}$, V_{OUT} Change=2% (Note)	—	120	300	
I_{SS}	Quiescent Current	$I_{OUT}=0\text{mA}$	—	2.5	4.0	uA
$\frac{\Delta V_{OUT}}{\Delta V_{IN} \times V_{OUT}}$	Line Regulation	$(V_{OUT}+2V) \leq V_{IN} \leq 30V$, $I_{OUT}=40\text{mA}$	—	0.2	0.4	%/V
$\frac{\Delta V_{OUT}}{\Delta T_a \times V_{OUT}}$	Temperature Coefficient	$I_{OUT}=40\text{mA}$, $-40^\circ\text{C} < T_a < 85^\circ\text{C}$	—	± 100	—	ppm/°C
I_{OCP}	Over Current Protection	$V_{IN}=12V$	—	350	700	mA

Note: Dropout voltage is defined as the input voltage minus the output voltage that produces a 2% change in the output voltage from the value at $V_{IN}=V_{OUT}+2V$ with a fixed load.

Typical Performance Characteristic

Test Condition: $V_{IN}=V_{OUT}+2V$, $I_{OUT}=10mA$, $C_{IN}=10\mu F$, $C_{OUT}=10\mu F$ and $T_a=25^\circ C$, unless otherwise noted

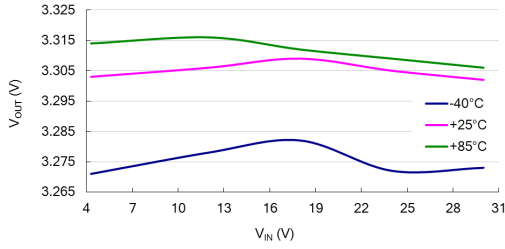

Line Regulation: HT7333-1 ($I_{OUT}=10mA$)

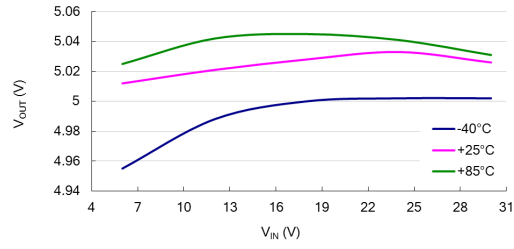

Line Regulation: HT7350-1 ($I_{OUT}=10mA$)

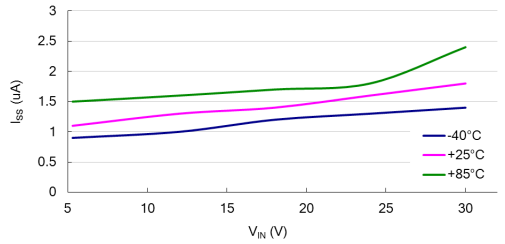

I_{SS} vs V_{IN} : HT7333-1 ($I_{OUT}=0mA$)

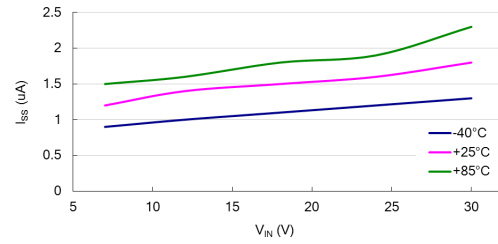

I_{SS} vs V_{IN} : HT7350-1 ($I_{OUT}=0mA$)

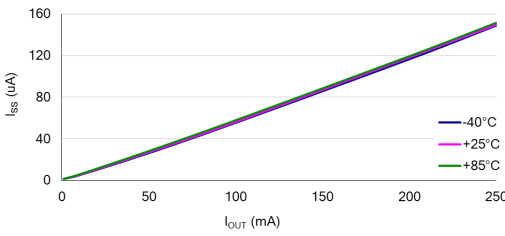

I_{SS} vs I_{OUT} : HT7333-1 ($V_{IN}=5.3V$)

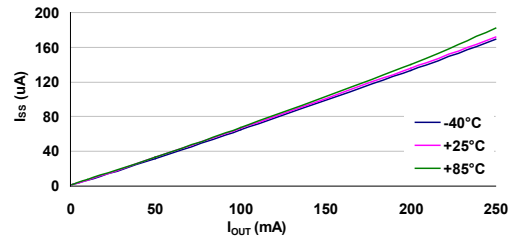

I_{SS} vs I_{OUT} : HT7350-1 ($V_{IN}=7.0V$)

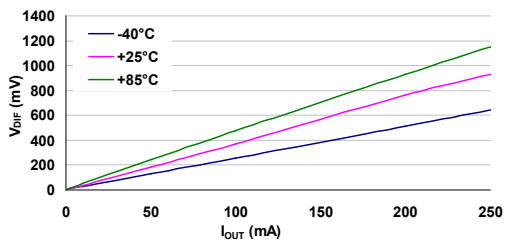

Dropout Voltage: HT7333-1

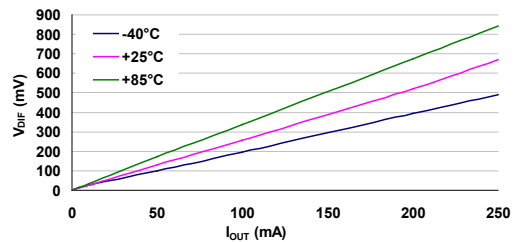

Dropout Voltage: HT7350-1

Test Condition: $V_{IN}=V_{OUT}+2V$, $I_{OUT}=10mA$, $C_{IN}=10\mu F$, $C_{OUT}=10\mu F$ and $T_a=25^\circ C$, unless otherwise noted

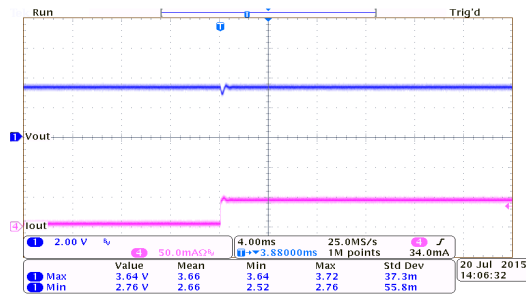

Load Transient Response:
HT7333-1 ($V_{IN}=5.3V$, $I_{OUT}=0mA$ to $40mA$)

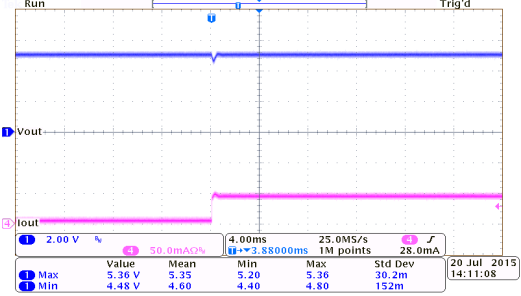

Load Transient Response:
HT7350-1 ($V_{IN}=7.0V$, $I_{OUT}=0mA$ to $40mA$)

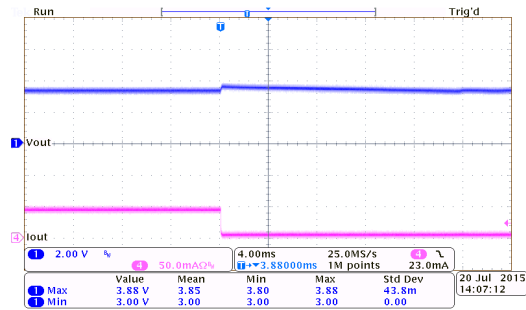

Load Transient Response:
HT7333-1 ($V_{IN}=5.3V$, $I_{OUT}=40mA$ to $0mA$)

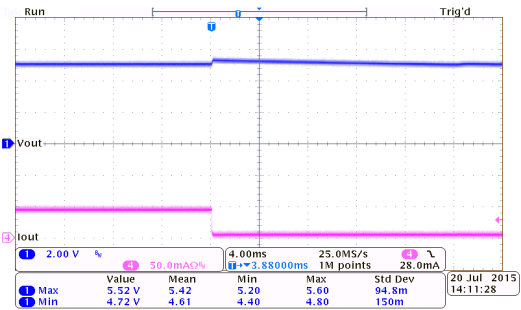

Load Transient Response:
HT7350-1 ($V_{IN}=7.0V$, $I_{OUT}=40mA$ to $0mA$)

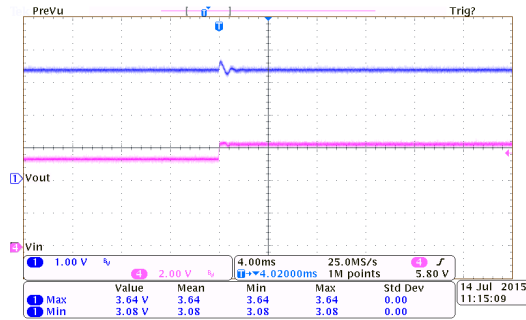

Line Transient Response:
HT7333-1 ($I_{OUT}=10mA$)

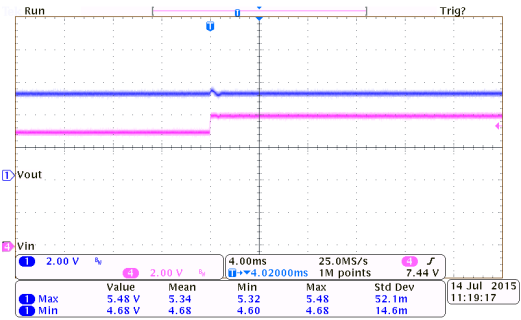

Line Transient Response:
HT7350-1 ($I_{OUT}=10mA$)

Test Condition: $V_{IN}=V_{OUT}+2V$, $I_{OUT}=10mA$, $C_{IN}=10\mu F$, $C_{OUT}=10\mu F$ and $T_a=25^\circ C$, unless otherwise noted

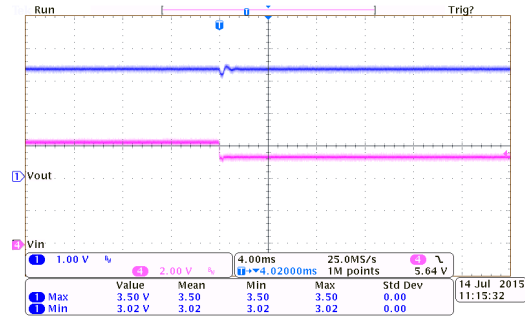

Line Transient Response:
HT7333-1 ($I_{OUT}=10mA$)

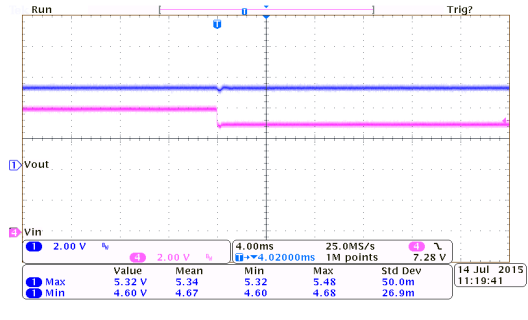

Line Transient Response:
HT7350-1 ($I_{OUT}=10mA$)

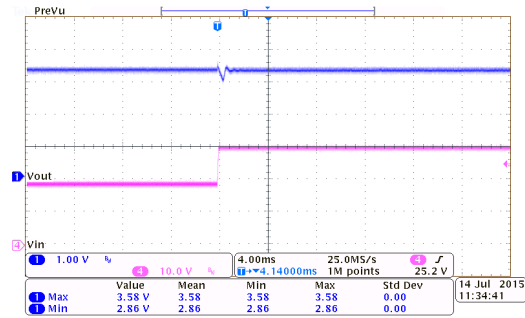

Line Transient Response:
HT7333-1 ($I_{OUT}=10mA$)

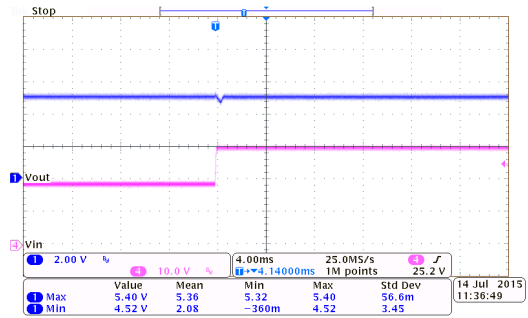

Line Transient Response:
HT7350-1 ($I_{OUT}=10mA$)

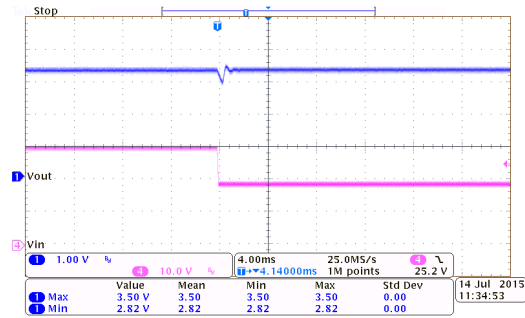

Line Transient Response:
HT7333-1 ($I_{OUT}=10mA$)

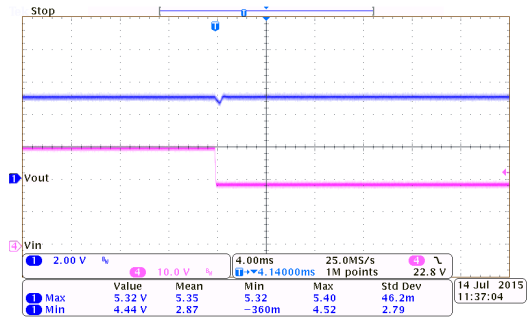

Line Transient Response:
HT7350-1 ($I_{OUT}=10mA$)

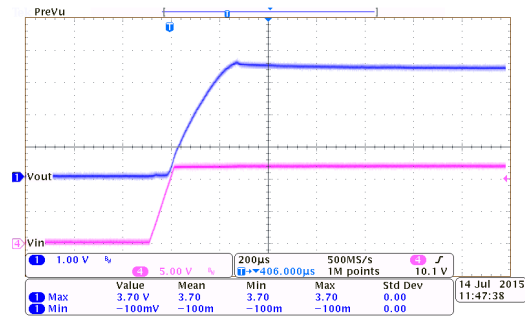

Power On Response:
HT7333-1 ($I_{OUT}=0mA$, $T_{RISE}=0.1ms$)

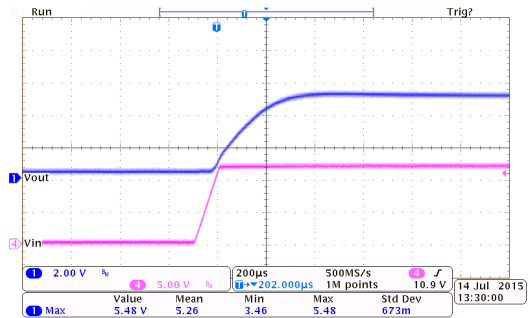

Power On Response:
HT7350-1 ($I_{OUT}=0mA$, $T_{RISE}=0.1ms$)

Test Condition: $V_{IN}=V_{OUT}+2V$, $I_{OUT}=10mA$, $C_{IN}=10\mu F$, $C_{OUT}=10\mu F$ and $T_a=25^\circ C$, unless otherwise noted

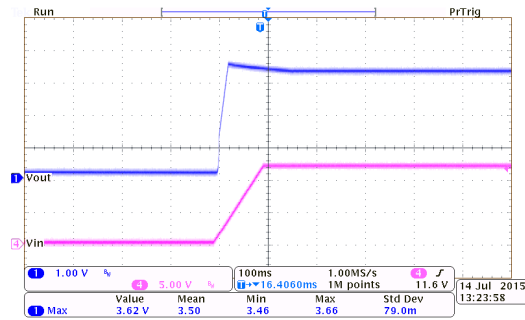

Power On Response:
HT7333-1 ($I_{OUT}=0mA$, $T_{RISE}=100ms$)

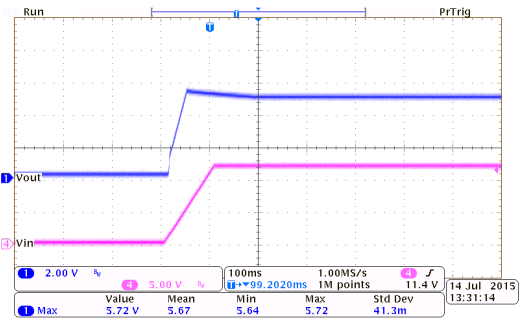

Power On Response:
HT7350-1 ($I_{OUT}=0mA$, $T_{RISE}=100ms$)

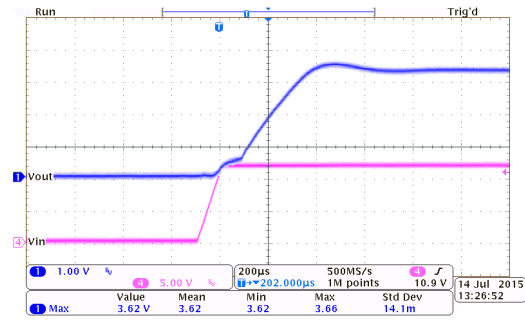

Power On Response:
HT7333-1 ($I_{OUT}=250mA$, $T_{RISE}=0.1ms$)

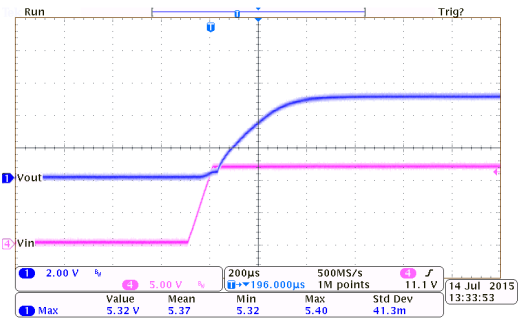

Power On Response:
HT7350-1 ($I_{OUT}=250mA$, $T_{RISE}=0.1ms$)

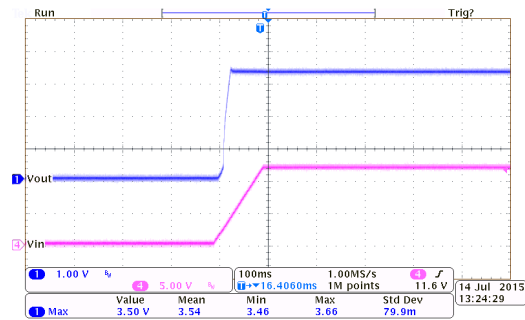

Power On Response:
HT7333-1 ($I_{OUT}=250mA$, $T_{RISE}=100ms$)

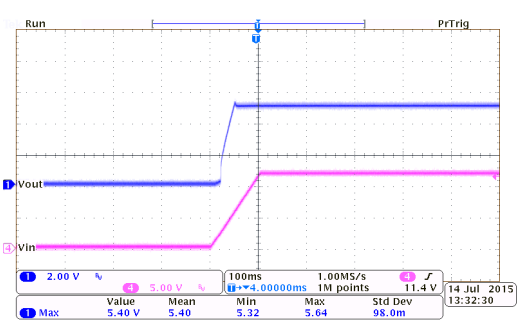

Power On Response:
HT7350-1 ($I_{OUT}=250mA$, $T_{RISE}=100ms$)

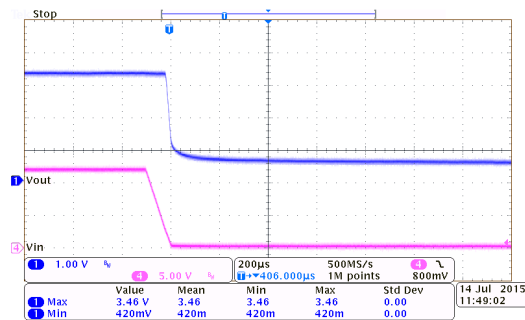

Power Off Response:
HT7333-1 ($I_{OUT}=0mA$, $T_{FALL}=0.1ms$)

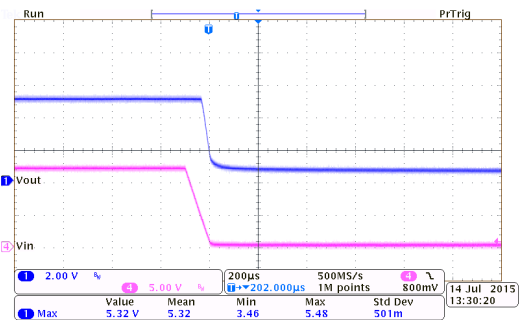

Power Off Response:
HT7350-1 ($I_{OUT}=0mA$, $T_{FALL}=0.1ms$)

Test Condition: $V_{IN}=V_{OUT}+2V$, $I_{OUT}=10mA$, $C_{IN}=10\mu F$, $C_{OUT}=10\mu F$ and $T_a=25^\circ C$, unless otherwise noted

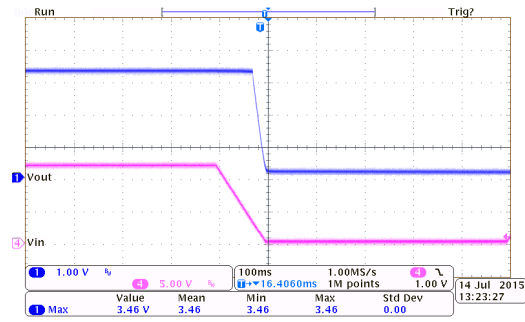

Power Off Response:
HT7333-1 ($I_{OUT}=0mA$, $T_{FALL}=100ms$)

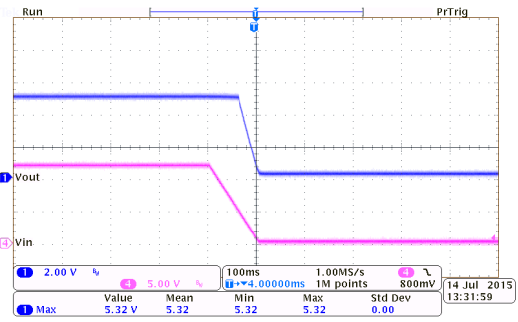

Power Off Response:
HT7350-1 ($I_{OUT}=0mA$, $T_{FALL}=100ms$)

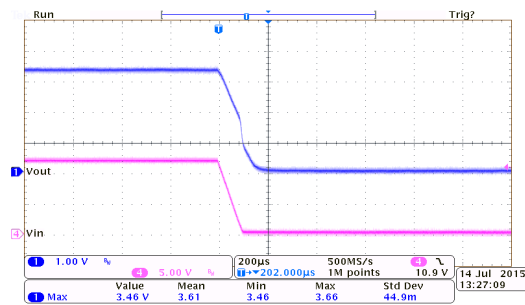

Power Off Response:
HT7333-1 ($I_{OUT}=250mA$, $T_{FALL}=0.1ms$)

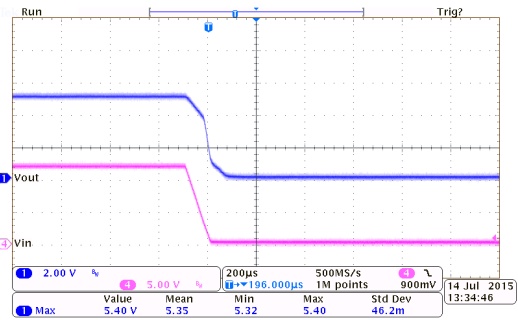

Power Off Response:
HT7350-1 ($I_{OUT}=250mA$, $T_{FALL}=0.1ms$)

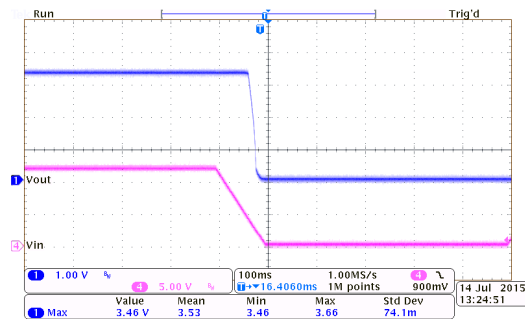

Power Off Response:
HT7333-1 ($I_{OUT}=250mA$, $T_{FALL}=100ms$)

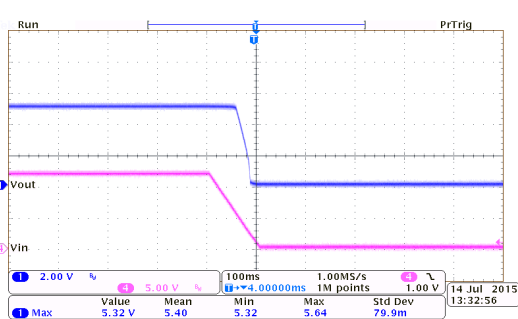

Power Off Response:
HT7350-1 ($I_{OUT}=250mA$, $T_{FALL}=100ms$)

Application Information

The devices are 3-terminal low dropout series linear voltage regulators. It is important the following application points are noted if correct operation is to be achieved.

External Circuit

It is important that external capacitors are connected to both the input and output pins. For the input pin suitable bypass capacitors as shown in the application circuits should be connected especially in situations where a battery power source is used which may have a higher impedance. For the output pin, a suitable capacitor should also be connected especially in situations where the load is of a transient nature, in which case larger capacitor values should be selected to limit any output transient voltages.

Thermal Considerations

The maximum power dissipation depends on the thermal resistance of the IC package, the PCB layout, the rate of the surrounding airflow and the difference between the junction and ambient temperature. The maximum power dissipation can be calculated by the following formula:

$$P_{D(MAX)} = (T_{J(MAX)} - T_a) / \theta_{JA}$$

where $T_{J(MAX)}$ is the maximum junction temperature, T_a is the ambient temperature and θ_{JA} is the junction-to-ambient thermal resistance of the IC package in degrees per watt. The following table shows the θ_{JA} values for various package types.

Package	θ_{JA} value °C/W
SOT89	200 °C/W
8SOP-EP	125 °C/W

For maximum operating rating conditions, the maximum junction temperature is 150°C. However, it is recommended that the maximum junction temperature does not exceed 125°C during normal operation to maintain an adequate margin for device reliability. The derating curves of different packages for maximum power dissipation are as follows:

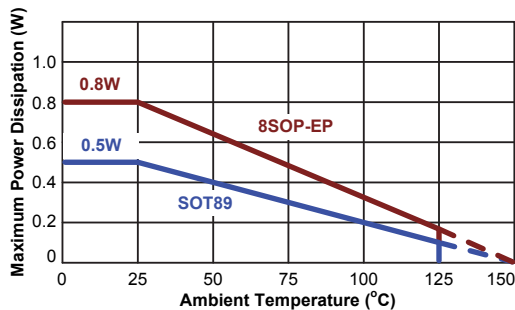

Power Dissipation Calculation

In order to keep the device within its operating limits and to maintain a regulated output voltage, the power dissipation of the device, given by P_D , must not exceed the Maximum Power Dissipation, given by $P_{D(MAX)}$. Therefore $P_D \leq P_{D(MAX)}$. From the diagram it can be seen that almost all of this power is generated across the pass transistor which is acting like a variable resistor in series with the load to keep the output voltage constant. This generated power which will appear as heat, must never allow the device to exceed its maximum junction temperature.

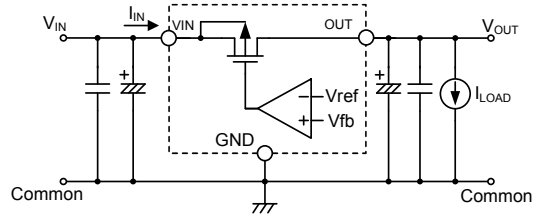

In practical applications the regulator may be called upon to provide both steady state and transient currents due to the transient nature of the load. Although the device may be working well within its limits with its steady state current, care must be taken with transient loads which may cause the current to rise close to its maximum current value. Care must be taken with transient loads and currents as this will result in device junction temperature rises which must not exceed the maximum junction temperature. With both steady state and transient currents, the important current to consider is the average or more precisely the RMS current which is the value of current that will appear as heat generated in the device. The following diagram shows how the average current relates to the transient currents.

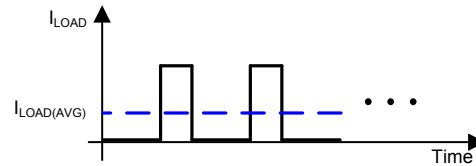

As the quiescent current of the device is very small it can generally be ignored and as a result the input current can be assumed to be equal to the output current. Therefore the power dissipation of the device, P_D , can be calculated as the voltage drop across the input and output multiplied by the current, given by the equation, $P_D = (V_{IN} - V_{OUT}) \times I_{IN}$. As the input current is also equal to the load current the power dissipation $P_D = (V_{IN} - V_{OUT}) \times I_{LOAD}$. However, with transient load currents, $P_D = (V_{IN} - V_{OUT}) \times I_{LOAD(AVG)}$ as shown in the figure.

Application Circuits

Basic Circuits

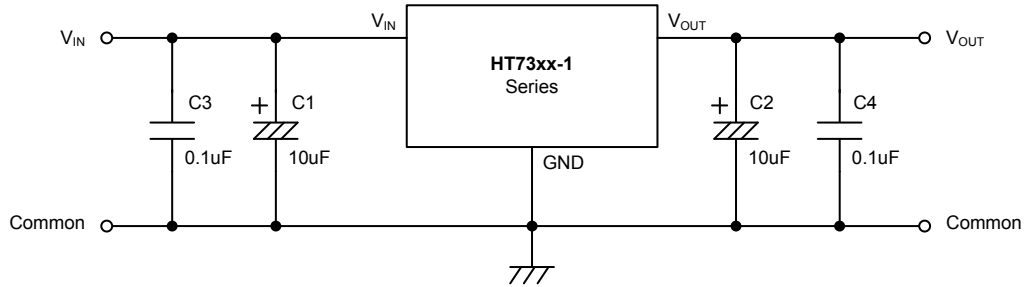

High Output Current Positive Voltage Regulator

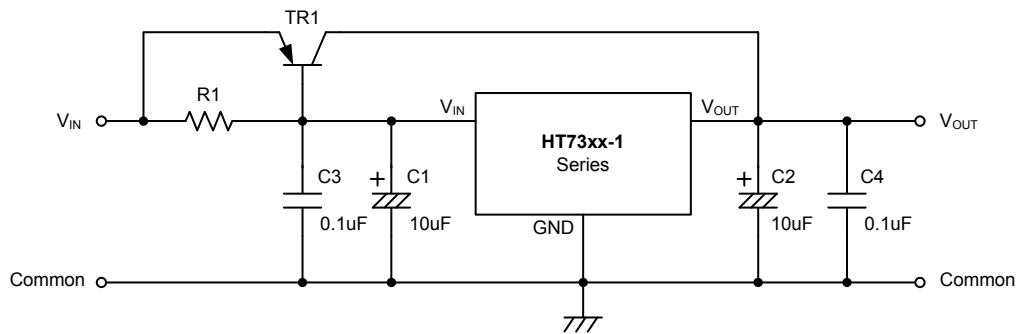

Circuit for Increasing Output Voltage

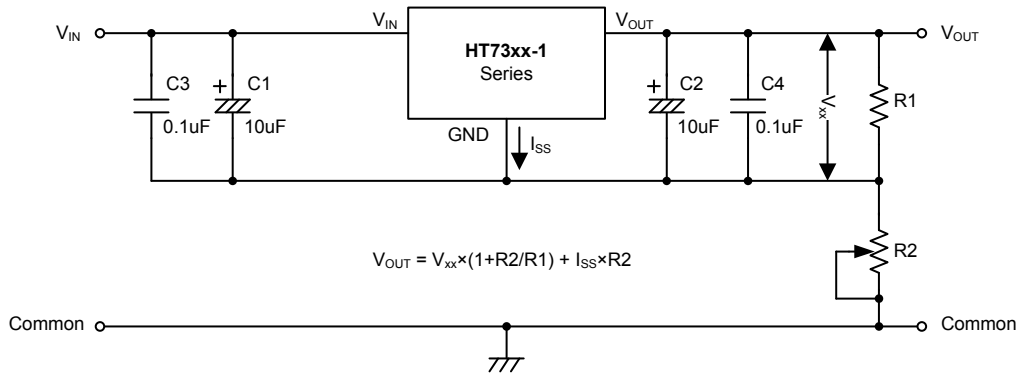

Circuit for Increasing Output Voltage

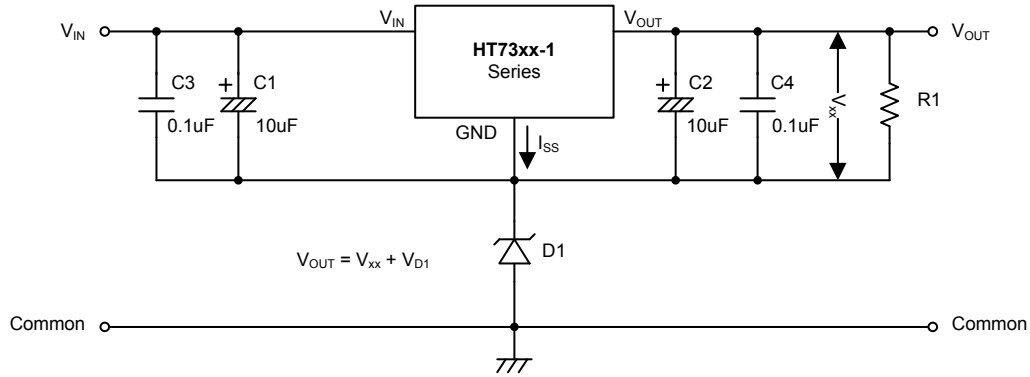

Constant Current Regulator

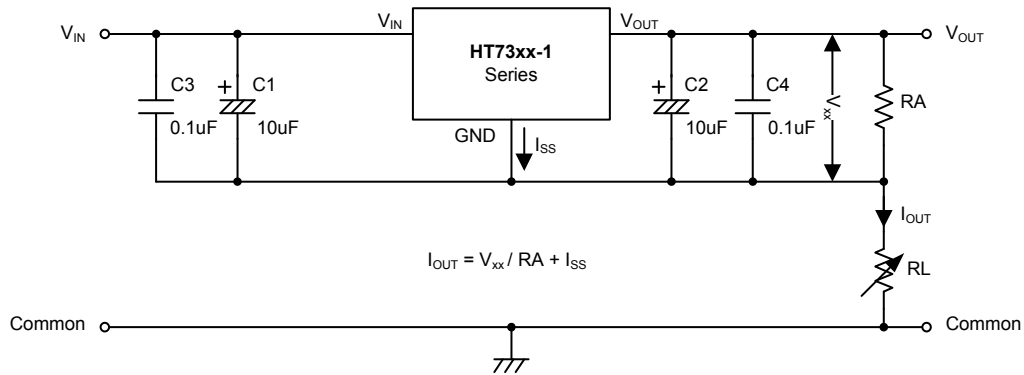

Dual Supply

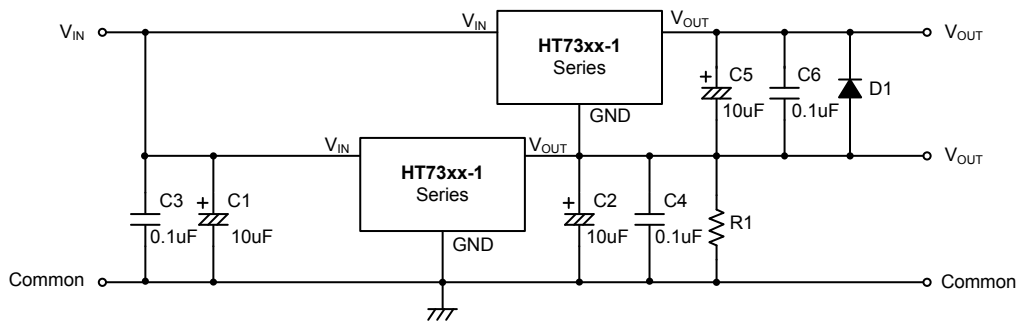

Package Information

Note that the package information provided here is for consultation purposes only. As this information may be updated at regular intervals users are reminded to consult

Additional supplementary information with regard to packaging is listed below. Click on the relevant section to be transferred to the relevant website page.

- [Package Information \(include Outline Dimensions, Product Tape and Reel Specifications\)](#)
- [The Operation Instruction of Packing Materials](#)
- [Carton information](#)

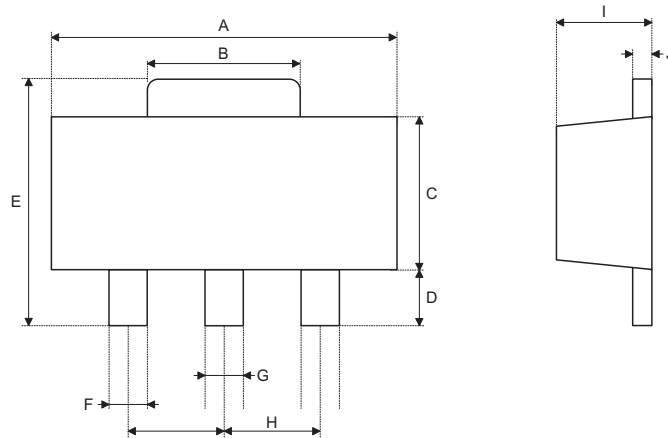
3-pin SOT89 Outline Dimensions

Symbol	Dimensions in inch		
	Min.	Nom.	Max.
A	0.173	—	0.185
B	0.053	—	0.072
C	0.090	—	0.106
D	0.031	—	0.047
E	0.155	—	0.173
F	0.014	—	0.019
G	0.017	—	0.022
H	—	0.059 BSC	—
I	0.055	—	0.063
J	0.014	—	0.017

Symbol	Dimensions in mm		
	Min.	Nom.	Max.
A	4.40	—	4.70
B	1.35	—	1.83
C	2.29	—	2.70
D	0.80	—	1.20
E	3.94	—	4.40
F	0.36	—	0.48
G	0.44	—	0.56
H	—	1.50 BSC	—
I	1.40	—	1.60
J	0.35	—	0.44

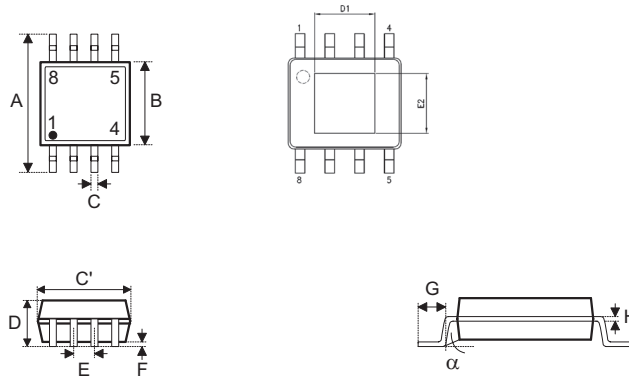
8-pin SOP-EP (150mil) Outline Dimensions

Symbol	Dimensions in inch		
	Min.	Nom.	Max.
A	—	0.236 BSC	—
B	—	0.154 BSC	—
C	0.012	—	0.020
C'	—	0.193 BSC	—
D	—	—	0.069
D1	0.059	—	—
E	—	0.050 BSC	—
E2	0.039	—	—
F	0.004	—	0.010
G	0.016	—	0.050
H	0.004	—	0.010
a	0°	—	8°

Symbol	Dimensions in mm		
	Min.	Nom.	Max.
A	—	6.00 BSC	—
B	—	3.90 BSC	—
C	0.31	—	0.51
C'	—	4.90 BSC	—
D	—	—	1.75
D1	1.50	—	—
E	—	1.27 BSC	—
E2	1.00	—	—
F	0.10	—	0.25
G	0.40	—	1.27
H	0.10	—	0.25
a	0°	—	8°

Copyright© 2018 by HOLTEK SEMICONDUCTOR INC.

The information appearing in this Data Sheet is believed to be accurate at the time of publication. However, Holtek assumes no responsibility arising from the use of the specifications described. The applications mentioned herein are used solely for the purpose of illustration and Holtek makes no warranty or representation that such applications will be suitable without further modification, nor recommends the use of its products for application that may present a risk to human life due to malfunction or otherwise. Holtek's products are not authorized for use as critical components in life support devices or systems. Holtek reserves the right to alter its products without prior notification.